

★★★★ villa
mercede
HOTEL&SPA

NUOVOCENTROCONGRESSI

@ VillaMercede





★★★★ villa
mercede
HOTEL & SPA

SALA CAMPITELLI

123 mq



Platea

90 PAX

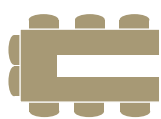

Ferro di Cavallo

35 PAX

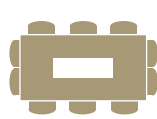

Tavolo Imperiale

35 PAX



Banchi di scuola

48 PAX



Banchetto

SECONDO
ALLESTIMENTO

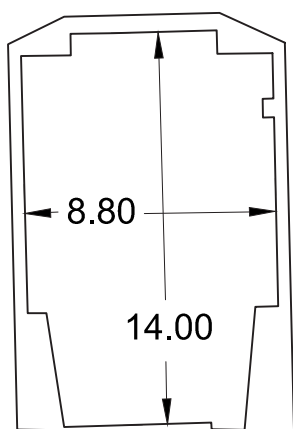

Dotazione

- 3 microfoni fissi
- 1 microfono wi-fi gelato
- 1 microfono archetto
- Luce naturale
- Videoproiettore
- Flip chart
- Schermo in 16:9
- Collegamento HDMI e VGA
- Free Wi-Fi
- Aria condizionata
- Puntatore laser
- Logitech presenter professional
- Welcome desk (su richiesta)
- Radiomicrofono amplificato
- Notebook collegabile a video screen (su richiesta)



WWW.VILLAMERCEDE.COM

Via Tuscolana, 20 - 00044 Frascati (RM)

TEL: +39 069424760

FAX: +39 069416461

congressi@villamercede.com



★★★★ villa
mercede
HOTEL & SPA

SALA TUSCOLO

23 mq



Platea

16 PAX

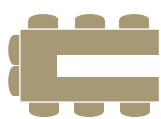

Ferro di Cavallo

ALLESTIMENTO
NON DISPONIBILE

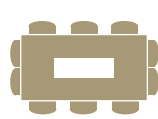

Tavolo Unico

12 PAX



Banchi di scuola

6 PAX



Banchetto

ALLESTIMENTO
NON DISPONIBILE

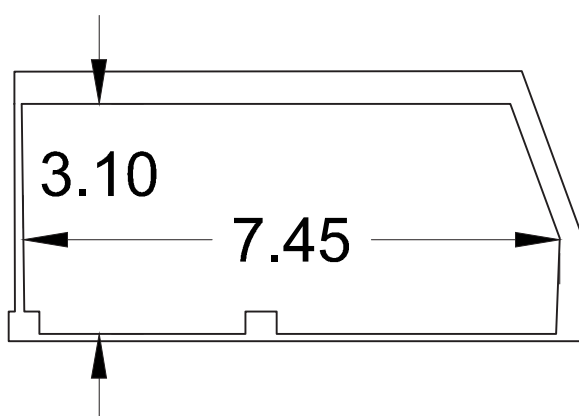

Dotazione

- Schermo LCD 50 pollici
- Flip chart
- Luce naturale
- Aria condizionata
- Notebook collegabile a video screen (su richiesta)
- Welcome desk (su richiesta)
- Free WI-FI
- Collegamento HDMI e VGA



WWW.VILLAMERCEDE.COM

Via Tuscolana, 20 - 00044 Frascati (RM)

TEL: +39 069424760

FAX: +39 069416461

congressi@villamercede.com



★★★★ villa
mercede
HOTEL&SPA

SALA CHIGI

45 mq

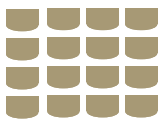

Platea

40 PAX

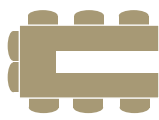

Ferro di Cavallo

20 PAX

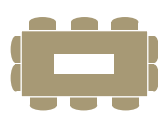

Tavolo Imperiale

20 PAX



Banchi di scuola

18 PAX



Banchetto

16 PAX

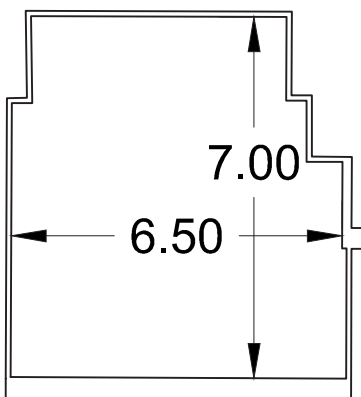

Dotazione

- 1 microfono wi-fi gelato
- 1 microfono archetto
- Luce naturale
- Videoproiettore
- Flip chart
- Schermo in 16:9
- Collegamento HDMI e VGA
- Free Wi-Fi
- Aria condizionata
- Puntatore laser
- Logitech presenter professional
- Radiomicrofono amplificato
- Welcome desk (su richiesta)
- Notebook collegabile a video screen (su richiesta)



WWW.VILLAMERCEDE.COM

Via Tuscolana, 20 - 00044 Frascati (RM)

TEL: +39 069424760

FAX: +39 069416461

congressi@villamercede.com

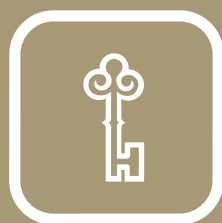

★★★★ villa
mercede
HOTEL&SPA

SALA TORLONIA

19 mq



Platea

8 PAX

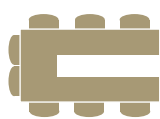

Ferro di Cavallo

ALLESTIMENTO
NON DISPONIBILE

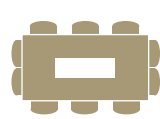

Tavolo Imperiale

10 PAX



Banchi di scuola

ALLESTIMENTO
NON DISPONIBILE



Banchetto

ALLESTIMENTO
NON DISPONIBILE

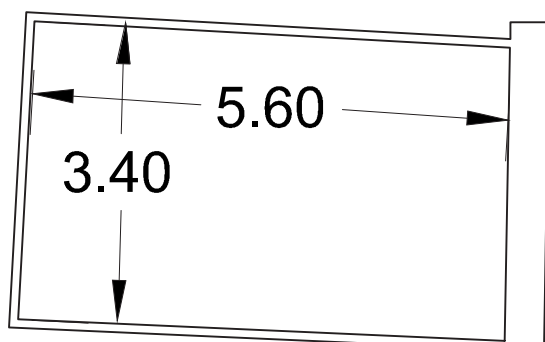

Dotazione

- Schermo LCD
- Flip chart
- Luce naturale
- Aria condizionata
- Notebook collegabile a video screen (su richiesta)
- Welcome desk (su richiesta)
- Free WI-FI



WWW.VILLAMERCEDE.COM

Via Tuscolana, 20 - 00044 Frascati (RM)

TEL: +39 069424760

FAX: +39 069416461

congressi@villamercede.com

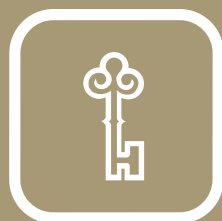

★★★★ villa
mercede
HOTEL&SPA

TARIFFE MEETING

	FULL DAY	1/2 DAY
SALA CAMPITELLI	€ 450.00	€ 350.00
SALA CHIGI	€ 300.00	€ 220.00
SALA TUSCOLO	€ 190.00	€ 150.00
SALA TORLONIA	€ 90.00	€ 70.00

+Iva 22%

SERVIZI AGGIUNTIVI

Servizio fax	€ 0,50/pg
Servizio fotocopie	€ 0,10/pg
Servizio copie a colori	€ 0,20/pg
Hostess in sala 1/2 day	€ 80,00
Hostess in sala full day	€ 100,00
Personale assistenza tecnica	€ 100,00
Secretariat office	€ 100,00

compresa Iva



WWW.VILLAMERCEDE.COM

Via Tuscolana, 20 - 00044 Frascati (RM)

TEL: +39 069424760

FAX: +39 069416461

congressi@villamercede.com

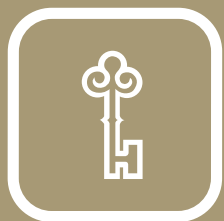

★★★★ villa
mercede
HOTEL&SPA

TARIFFE CATERING

COFFEE STATION € 10,00 p.p.

Acqua, thermos di caffè e the, biscotteria secca

COFFEE BREAK da € 12,00 p.p. / n.m.g. 20 p.p.

Acqua, thermos di caffè e the
Mini tramezzini, mini croissant, frutta fresca, biscotteria secca
LOCATION: Lounge Bar - Garden

APERITIVO RINFORZATO da € 20,00 p.p. / n.m.g. 20 p.p.

Acqua, bevande analcoliche, prosecco, frittini, mini tramezzini,
affettati, bruschette, rustici
LOCATION: Lounge Bar - Piscina - Garden

WORKING LUNCH da € 35,00 p.p.

3 portate, inclusi 1/2 lt di acqua minerale e 1 calice di vino DOC Frascati
LOCATION: Sala view del ristorante - Garden

WORKING DINNER da € 50,00 p.p.

4 portate, inclusi 1/2 lt di acqua minerale e 1 calice di vino DOC Frascati
LOCATION: Sala view del ristorante - Garden

GALA MENU da € 65,00 p.p.

LOCATION: Sala view del ristorante - Bordo Piscina
(Con quotazione da personalizzare)

Prezzi Iva Inclusa



WWW.VILLAMERCEDE.COM

Via Tuscolana, 20 - 00044 Frascati (RM)

TEL: +39 069424760

FAX: +39 069416461

congressi@villamercede.com